



KEVA[®]

EDUCATOR'S GUIDE

Activities and Lesson Plans for KEVA[®] Planks



www.mindware.com

KEVA[®]

EDUCATOR'S GUIDE

Activities and Lesson Plans for KEVA[®] Planks

©2007 KEVA planks. All rights reserved. Printed in the United States of America.

Notice! Pages may be reproduced for classroom or home use only, not for commercial resale. No part of this publication may be reproduced for storage in a retrieval system, or transmitted in any form or by any means—electronic, mechanical, recording, etc.—without the prior written permission of MindWare. Reproductions of consumable student handouts found in the appendix may be made for schoolwide use, but system-wide reproduction is prohibited.



Table of Contents

- iv Foreword
- v KEVA Uses
- vi Basic Instructions for Building
- viii Team Building and Incentives
- xi For Young Children
- xii Correlation to National Standards for Math, Science, Social Studies and Art

MATHEMATICS AND SCIENCE

- 1.1 Counting with KEVA
- 1.2 Number Recognition
- 1.3 Reasonable Guess of Magnitude
- 1.4 Adding with KEVA
- 1.5 Subtracting with KEVA
- 1.6 Comparing with KEVA
- 1.7 Estimating with KEVA
- 1.9 Graphing with KEVA
- 1.10 Measuring Perimeter with KEVA
- 1.11 Area (or KEVA²)
- 1.12 Volume (or KEVA³)
- 1.13 KEVA as a Non-Standard Unit of Measurement
- 1.14 Measuring with KEVA for Older Students
- 1.15 Geometric Shapes with KEVA
- 1.16 KEVA Polygons
- 1.17 KEVA Cantilevers
- 1.18 Why Does the Earth Look Flat?

SOCIAL STUDIES

- 2.1 The Battle of Yorktown
- 2.2 KEVA Pyramids
- 2.3 Great Wall of China
- 2.4 KEVA Geography
- 2.5 Jamestown Fort
- 2.6 KEVA Economics
- 2.7 Natural Resources

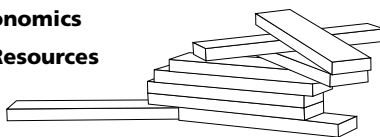

ART

- 3.1 All-Purpose Lesson Plan for Art
- 3.2 A KEVA Sculpture Garden
- 3.3 Form and Function
- 3.4 International Architecture
- 3.5 Moving from 2D to 3D
- 3.6 2D Designs
- 3.7 Building 3D Themed Sculptures
- 3.8 Minimalism
- 3.9 The Same, Yet Different
- 3.10 KEVA Art Games

LANGUAGE ARTS

- 4.1 KEVA ABCs
- 4.2 Following Directions with KEVA
- 4.4 Build a KEVA World
- 4.5 KEVA Settings, Characters and Plots
- 4.7 KEVA News
- 4.8 Literature Links

APPENDICES

- A Adding with KEVA
- B Subtracting with KEVA
- C Estimating with KEVA
- D Graphing with KEVA • Data Sheet
- E Graphing with KEVA • Bar Graph
- F KEVA Yardstick
- G KEVA² Template
- H KEVA³ Template
- I Geometric Shapes
- J KEVA Cantilevers • Data Sheet
- K KEVA Cantilevers • Classroom Data Chart
- L Habitat Cards
- M Character Description
- N KEVA People



Foreword

KEVA planks have diverse educational benefits.

As I have taken construction planks into classrooms, I have repeatedly seen children respond with enthusiasm to the challenges and activities I have presented to them. KEVA planks are a great equalizer in the classroom. Children of varying abilities can find success quickly. Girls as well as boys seem to think that KEVA planks are “cool.” It also seems to grow up with the children; KEVA activities can be challenging to both a five year old and an accomplished architect.

Aside from the benefits of building creatively, KEVA planks are also a great tool for meeting specific educational goals. In social studies, building activities can be tailored to match the culture or society that you are studying. The uniformity of the planks lends itself to numerous math and science applications. The versatility of KEVA planks makes them an ideal tool for imaginative activities in art and language arts. KEVA planks gently nudge artistic minds toward science and motivates scientific, mathematically minded students to think more artistically.

These lesson plans and activities were developed during the course of conducting workshops in schools, children’s museums and science museums. These sessions are designed to transform a wide variety of topics into kinesthetic learning adventures. Each lesson plan was written to support the particular learning objectives of the teacher.

The lessons in this book are arranged in order of increasing complexity for each section. However, many of the ideas presented throughout can be modified in part or in whole to use for younger or older students.

I hope you will enjoy the activities in this book. I know you will find KEVA planks to be a wonderful addition to your classroom.

Jane Fowler

Teacher and Educational Consultant



KEVA EDUCATOR'S GUIDE

KEVA[®] Uses

KEVA planks are great for:

Constructing simple and complex designs, for builders of all ages.

Making history come alive by building pyramids, castles, cityscapes, boats, bridges, towers and more.

Creating beautiful wooden sculptures. (You may want to use a camera to capture these masterpieces.)

Using as manipulatives for counting.

Teaching units of measurement. The uniformity of KEVA planks can be used as measurement standards in 1, 2 or 3 dimensions.

Teaching concepts of economics, such as scarcity, natural resources and human resources.

Prompting group discussion and cooperation. Build a world together: plan, build and present.

Making mazes and amazing patterns.

Allowing a child to solve 3D problems.

Teaching principles of cantilever and balance.

Extending literature into the classroom. Re-create exotic or familiar settings from great stories.

Fostering creativity and imagination. The simplicity and uniformity of KEVA planks allows limitless possibilities in construction!



K=Knowledge

E=Exploration

V=Visual

A=Arts

For information on KEVA and planks workshops, visit www.KEVaplanks.com



Basic Instructions for Building

The following is a list of general tips that will be helpful for both you and your students. Everything mentioned could be discovered by a child if they are given time to experiment, but offering a few tips will help students get a good start. This list will also help to establish some basic terminology in building that will be helpful when using with the rest of the lesson plans in this book.

1. It is best to build on a floor rather than a table, which can be easily bumped.

If the surface of your floor is uneven, you can create an even surface by laying planks flat, side by side, as a building platform.

2. There are three ways to stack KEVA planks.

In this book they will be referred to as:

- 1) Flat side 2) Edge 3) End

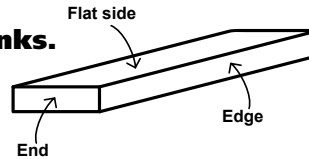

3. You can also build by leaning or angling the KEVA planks.

Although this method will not bear weight unless heavily braced, it can be used effectively for accent elements, especially for roofs.

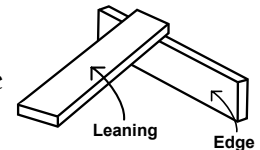

4. Spirals. Spirals make beautiful accents and are easy to construct. Begin by laying a plank flat (*fig.1*). Lay another plank flat directly on top of the first plank, but offset a tiny bit (about 10 degrees). Be sure that your spacing is the same at each end of the planks so your spiral will stay centered. Continue this process to create a spiral (*fig.2*). Larger and more intricate spirals can be made with 2, 3 or 4 planks on each layer. The basic steps are the same. Begin with one flat layer (*fig.3*). Line up the next layer exactly, with a slight twist (*fig.4*).



5. Bowls, Domes and Globes. Start with a square, hexagon, octagon or larger closed figure built by laying the KEVA planks flat in two rows, the second bisecting the first (*fig.5*). Then, with each successive layer, place each plank a small (5mm) step outward. With each layer the figure will have a greater outer diameter. Eventually you will find you cannot move out any farther or the piece will topple. You may now build straight up or begin placing the planks a small step inward to create a dome. The key to this type of construction is using small steps. (*Refer to photo on back cover of guide*).

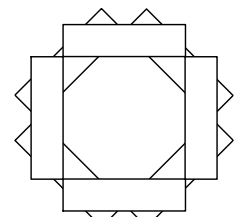

fig.5



- 6. Angled or Zigzag Towers.** These towers can be built by laying the planks flat or on edge. From your base, offset each successive layer by a small amount (several millimeters) in one direction. After several layers (4–6), before the tower begins to become unstable, offset the next 4 to 6 layers by several millimeters each in the opposite direction. This can be continued for several angles using decreasing numbers of layers before the tower loses stability.
- 7. Bridges and Spans.** Start with 2 or more pedestals, spaced 2 to 3 plank lengths apart. Build the pedestals first, using any combination of flat, edge or end construction. The pedestals can be short or tall, narrow or large. After constructing the pedestals, use cantilever techniques (*see page 1.17*) to span the distances between the pedestals using flat or edge construction. After practicing several times, you will be able to get the planks to meet in the middle making a perfect fit for whatever span design you are constructing. As with other cantilever constructions, several layers of planks built on top of the spans above and between the pedestals will increase the stability of the entire structure. Once the structure is secured in this manner, it can support the weight of houses, trains or other creations built on the span.



INCENTIVES AND REWARD SYSTEMS

KEVA can be used as an excellent positive reinforcement tool. If you use a reward system in your classroom, consider using KEVA as a part of it. For a certain number of points, a child could either earn minutes of building time during their free time, or they could earn a certain number of KEVA planks with which to build. A dedicated builder would be motivated to acquire as many blocks for his or her daily or weekly building time as possible.

TIPS TO CUSTOMIZE ACTIVITIES

Most of the activities in this book can be easily modified by adjusting the number of planks that are used. If fewer planks are used, the activity will take less time and usually will be easier. Adjust every activity according to the number of planks you have, the number of students, the skill level or experience, the amount of time you have and your learning objectives.

STUDENTS TEACHING STUDENTS

Students will observe the innovations of other builders and develop more and more construction techniques. Over time, you will see more complex structures being built because of the shared knowledge base. It is fascinating to watch the progression of innovation in a classroom. It is important to recognize and praise the construction accomplishments of students.



Team Building and Incentives

KEVA planks are a great resource to have in the classroom for team-building activities. While working together on creative and challenging assignments, students will learn cooperation and communication skills. KEVA challenges can be used to boost self-confidence as well. Most of all, KEVA planks are a fun way to bring students together in mind-stretching activities.

CHALLENGES AND TEAM BUILDING

Here are some quick challenges that will require students to use creativity and coordination. They can be given to individuals or to small groups. Many of these activities work well as team-building exercises. Students who work together without arguing will be more successful than students who do not. Camaraderie is also established as groups plan together and successfully complete their goals.

- 1. Build the Tallest Tower (with a limited number of blocks)** For this activity you specify the amount of blocks each student or group will be given—50 to 200 planks can be used depending on the age of the students and the time limit. Have the students count out the amount. In a very competitive crowd, you can then have the students switch piles of KEVA and recount their planks. The student or group that can build the tallest tower with a set amount of planks would win the challenge. You can do this activity with a time limit or without. With a time limit, you will be emphasizing speed. Without a time limit, you will be emphasizing skill in building techniques.
- 2. Build the Widest Bridge Span** Have the students build two columns and challenge them to create the longest span between the columns without a support beneath it. For this activity students will need to have equal number of KEVA planks—50 to 200 planks can be used depending on the age of the students and the time limit. Have the students count out the amount. Again, in a very competitive crowd you can then have the students switch piles of KEVA and recount their planks. You can do this activity with a time limit or without. With a time limit, you will be emphasizing speed. Without a time limit, you will be emphasizing skill in building techniques.
- 3. A Quick Warm-up Activity** Ask students to build a tower taller than themselves in 5 minutes. Fifty to 100 planks will be enough for each student if they are brave and skilled enough to build with the planks on the end.



4. Build a Dome Ask students to build a dome that encloses an object. If you have access to a lot of KEVA planks, you can have a group of students build a dome that encloses a student. The captured student will have to break out after the building is completed.

5. KEVA Topple Have students build a tall tower alternating end construction and flat or edge construction. After the tower is 4 feet high or higher, students can see if they can carefully tap away some of the lower planks. The taller the tower, the easier this is to do without toppling the structure. Students can experiment to discover how tall the tower must be, and they can come up with a theory as to why this works.

6. KEVA Relay This activity emphasizes balancing skills using KEVA planks. Have students hold a KEVA plank by its end, flat side up. Balance another plank on top of this one on its flat side or edge. You can begin your relay race from this point or from the point of picking up the plank. The competitors will need to walk a short distance as they keep their planks balanced. If they drop their planks, they must rebalance them before they continue.

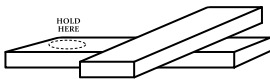

7. Balancing Act This activity emphasizes balancing skills using KEVA planks. Have students hold a KEVA plank by its end, flat side up. Balance another plank on top of this one on its flat side. Students can now attempt to add more planks to their stack, all the while holding only one plank by its end. Students can compete against one another, but time should not be a factor because this is a slow and steady activity that takes concentration. You can make this a much harder activity by turning the KEVA planks on their edge. To balance 3 planks on edge is very hard, and 6 is an international record!

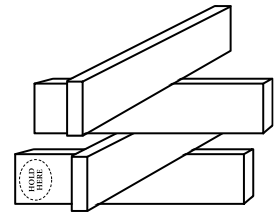

8. KEVA Mazes Use KEVA planks to build 3D mazes on the floor of your classroom. This can be done by laying planks flat or on their edge. After one student or group of students have constructed a maze, other students can try to solve the maze using a toy car or plastic figure. Challenge mazes can also be made in the shape of familiar objects.

9. Tower Relay Give each team 200 KEVA planks. Have the students count out the exact amount; opposite teams can verify the counting. The relay will consist of each team building a tower of any shape with their planks. Once their tower is completed using all 200 planks, they will dismantle it without allowing it to topple and reassemble it on the opposite side of the room. They may use only their hands to carry the planks. No shirts can be used as buckets, and no pinning planks against their bodies. The first team to complete the second tower is the winner. The children will be most successful if they work as a team to build, disassemble and carry the KEVA planks. You may want to allow time for the children to



discuss the division of labor before they begin, or you may wish for them to discover this along the way. A variation of this relay can be done by not allowing any talking.

10. Bridge Relay Give each team 200 KEVA planks. Have students count out the exact amount; opposite teams can verify the counting. The relay will consist of each team building a bridge of any shape with their planks. The bridge must span at least three columns. Once their bridge is completed using all 200 planks, they will dismantle it without allowing it to topple and reassemble it on the opposite side of the room. They may use only their hands to carry the planks. No shirts can be used as buckets, and no pinning planks against their bodies. The first team to complete the second bridge is the winner. The children will be most successful if they work as a team to build, disassemble and carry the KEVA planks. You may want to allow time for the children to discuss the division of labor before they begin, or you may wish for them to discover this along the way. A variation of this relay can be done by not allowing any talking.

11. Interconnected Building This can be done with 5 to 30 children. Each student will need about 200 KEVA planks. Have the students form a circle and then sit down with their plank piles. Students should work on the outside of the circle facing inward. Students will be building a tower 6 to 12 inches high. You must determine the height beforehand to ensure uniformity. The easiest thing to do is to build the towers all together as a group to insure the exact height. As one person builds have him or her call out the directions for each row. (*For example: Row #1 = 2 planks laid flat, parallel to one another; Row #2 = 2 planks laid on edge, perpendicular to Row #1.*) These structures should be no more than two plank lengths apart. After this is completed, have the students bridge the towers—each student working in both directions to meet his or her neighbors in the middle. The spans could be made in various ways or a uniform method could be suggested.





For Young Children

FOLLOW THE LEADER: GUIDED BUILDING

For young children or low-skill-level students, try a guided building activity. The following is an example of a progression of activities that could be done one-on-one or with a room full of students. You can build and imagine right along with them. Emphasize verbal or visual clues as needed or according to your objectives. Give students the chance to respond first. However, if they do not understand your verbal instruction, a glimpse at your moves may be all that is needed. **USE YOUR OWN IMAGINATION.** Try adding a story as you build, and allow the children to add to the story. This is so adaptable, you can use it to reinforce virtually any learning objective.

Let's do it (*You could read this out loud to students, but it is better if you go with the flow*).

How many sides does a triangle have? Can you make a triangle? Show me three different ways you could make a triangle. Show me three more ways to make a triangle. See if you can make the number by laying planks flat on the table. Make three stacks of three. Without counting them, do you know how many planks are in two piles of three?



How many sides does a square have? Could you show me a square using 4 planks? Show me a square using 8 planks. Add four layers to your square. Let's pretend this is a house. (*See back cover of the KEVA Curriculum for a simple house. The roof can be flat for more simplicity.*) Whose house should it be? Let's make another house of a friend. Make a road or a sidewalk so the friends can easily visit each other.

Let's make a pond that they could fish in. (*Make an irregular shaped figure flat on the floor or table*)

Do you know how to make a tree or a bush? Make a bush that is exactly 7 planks high. Make a bush that is 12 planks high (*fig.6*).

Make a road or sidewalk leading somewhere. Let's put another building by the road. What should it be? (*Another friend's house? Grocery store? Restaurant?*)

Let's make a tall building.

What else would you like to make?

...And you are on your way. Try letting a student lead in a follow-the-leader type activity.



fig.6
Here is an example of a tree. A bush is just the top part of the tree.

Correlation to National Standards for Math, Science, Social Studies and Art

Math and Science Activities	Page	Suggested grade level(s)	NCTM (Math) Standards-Numbers	NCTM (Math) Standards-Algebra	NCTM (Math) Standards-Geometry	NCTM (Math) Standards-Spatial Relationships	NCTM (Math) Standards-Measurement	NCTM (Math) Standards-Data Analysis and Probability	NCTM (Math) Standards-Problem Solving	NSTA (Science) Standards	NCSS (Social Studies) Standards	ITEA (Technology) Standards - Design
Spirals	vi	All			All	All			All			All
Bowls, Domes, Globes	vi	All			All	All			All			All
Angled or Zigzag Towers	vii	All			All	All			All			All
Bridges and Spans	vii	All			All	All			All			All
Tallest Tower	viii	All	K-2		K-2	K-2			K-2			K-2
Widest Bridge	viii	All	K-2		K-2	K-2			K-2			K-2
Warm-up	viii	All	K-2		K-2	K-2			K-2			K-2
Dome	ix	All	K-2		K-2	K-2			K-2			K-2
Topple	ix	All	K-2		K-2	K-2			K-2			K-2
Relay	ix	All	K-2		K-2	K-2			K-2			K-2
Balancing Act	ix	All	K-2		K-2	K-2			K-2			K-2
Mazes	ix	All	K-2		K-2	K-2			K-2			K-2
Tower Relay	ix	All	K-2		K-2	K-2			K-2			K-2
Bridge Relay	x	All	K-2		K-2	K-2			K-2			K-2
Interconnected Building	x	All	K-2		K-2	K-2			K-2			K-2
Triangles and Squares	xi	K-2	K-2		K-2	K-2			K-2			K-2
House, road, pond, tree	xi	K-2	K-2		K-2	K-2			K-2		K-2	K-2
Counting	1.1	K-2	K-2		K-2	K-2			K-2			K-2
Number Recognition	1.2	K-2	K-2		K-2	K-2			K-2			K-2
Reasonable Guess	1.3	K-2	K-2		K-2	K-2			K-2			K-2
Adding	1.4	K-2	K-2		K-2	K-2			K-2			
Subtracting	1.5	K-2	K-2		K-2	K-2			K-2			
Comparing	1.6	K-2	K-2	K-2	K-2	K-2	K-2		K-2			

Math and Science Activities	Page	Suggested grade level(s)	NCTM (Math) Standards- Numbers	NCTM (Math) Standards- Algebra	NCTM (Math) Standards- Geometry	NCTM (Math) Standards- Spatial Relationships	NCTM (Math) Standards- Measurement	NCTM (Math) Standards- Data Analysis and Probability	NCTM (Math) Standards- Problem Solving	NSTA (Science) Standards	NCSS (Social Studies) Standards	ITEA (Technology) Standards - Design
Estimating	1.7	K-2	K-2		K-2	K-2	K-2	K-2	K-2			
Graphing	1.9	K-2	K-2					K-2	K-2			
Perimeter	1.10	3-5	3-5	3-5	3-5	3-5	3-5	3-5	3-5			
Area	1.11	3-5	3-5	3-5	3-5	3-5	3-5	3-5	3-5			
Volume	1.12	3-5	3-5	3-5	3-5	3-5	3-5	3-5	3-5			
Non-Standard Measure	1.13	K-2	K-2	K-2			K-2		K-2			
Measuring and Ratios - Older Students	1.14	3-5	3-5			3-5			3-5			
Geometric Shapes	1.15	K-2, 3-5			K-2, 3-5				K-2, 3-5			
Polygons and Interior Angles	1.16	4-6			4-6	4-6			4-6			
Cantilevers, Controls and Variables	1.17	3-5, 6-8			3-5, 6-8	3-5, 6-8			3-5, 6-8	6-8		3-5, 6-8
Flat Earth	1.18	3-5			3-5	3-5				3-5		
Social Studies Activities	Page	Suggested grade level(s)	NCSS (Social Studies) Standards - Culture	NCSS (Social Studies) Standards - Time, Continuity and Change	NCSS (Social Studies) Standards - Places and Environments	NCSS (Social Studies) Standards - Production, Distribution Consumption	NCSS (Social Studies) Standards - Science, Technology and Society	NCTM (Math) Standards- Problem Solving	NCTE (Lang Arts) Standards	NSTA (Science) Standards	ITEA (Technology) Standards- Technology and Society Integration	
Battle of Yorktown	2.1	3-5	3-5	3-5			3-5		3-5		3-5	
Pyramids	2.2	6-8	6-8	6-8			6-8		6-8		6-8	
Great Wall of China	2.3	6-8	6-8	6-8			6-8	6-8			6-8	
Geography	2.4			6-8								
Jamestown Fort	2.5	3-5	3-5	3-5			3-5				3-5	
Economics	2.6					5				5	5	
Natural Resources	2.7					3-5, 6-8				3-5, 6-8	3-5, 6-8	

Art Activities	Page	Suggested grade level(s)	NCTM (Math) Standards-Geometry	NCTM (Math) Standards-Spatial Relationships	NCTM (Math) Standards-Algebra	NSTA (Science) Standards	NCSS (Social Studies) Standards - Culture	NCSS (Social Studies) Standards - Time, Continuity and Change	NCSS (Social Studies) Standards - People, Places and Environments	NCTE (Lang Arts) Standards	ITEA (Technology) Standards
Sculpture Garden	3.2	K-2, 3-5, 6-8		K-2, 3-5, 6-8					K-2, 3-5, 6-8		
Form and Function	3.3	3-5, 6-8		3-5, 6-8		3-5, 6-8	3-5, 6-8	3-5, 6-8	3-5, 6-8		3-5, 6-8
International Architecture	3.4	3-5, 6-8		3-5, 6-8			3-5, 6-8	3-5, 6-8	3-5, 6-8		3-5, 6-8
Moving From 2D to 3D	3.5	3-5, 6-8	3-5, 6-8	3-5, 6-8							
2-Dimensional Designs	3.6	3-5, 6-8	3-5, 6-8	3-5, 6-8	3-5, 6-8						
3D Themed Sculptures	3.7	3-5, 6-8	3-5, 6-8	3-5, 6-8							
Minimalism	3.8	3-5, 6-8		3-5, 6-8							
The Same Yet Different	3.9	3-5, 6-8		3-5, 6-8	3-5, 6-8						
Art Games	3.10	K-2, 3-5, 6-8		K-2, 3-5, 6-8						K-2, 3-5, 6-8	
Language Arts Activities	Page	Suggested grade level(s)	NCTE (Lang Arts) Standards - Written Language	NCTE (Lang Arts) Standards - Spoken Language	NCTE (Lang Arts) Standards - Texts	NCTM (Math) Standards - Algebra	NSTA (Science) Standards	NCSS (Social Studies) Standards	ITEA (Technology) Standards		
ABCs	4.1	K-2	K-2								
Following Directions	4.2	K-2		K-2		K-2					
KEVA World	4.4	K-2						K-2	K-2		
Settings, Characters, Plots	4.5	K-2, 3-5	K-2, 3-5		K-2, 3-5			K-2, 3-5	K-2, 3-5		
News	4.7	K-2, 3-5	K-2, 3-5					K-2, 3-5	K-2, 3-5		
Literature Links	4.8	K-2, 3-5	K-2, 3-5		K-2, 3-5			K-2, 3-5	K-2, 3-5		

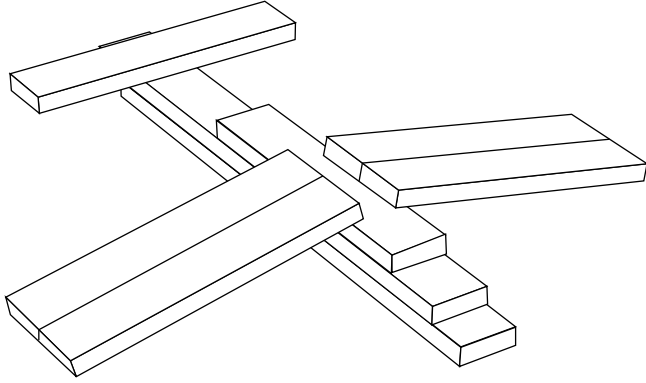

MATHEMATICS AND SCIENCE



Counting with KEVA®

OBJECTIVE: Students will count forward from 1 through 30 and backward from 10.

MATERIALS:

- 30 KEVA planks per student or small group
- Small containers for each student (shoe boxes or paper bags)

PROCEDURE:

- 1.** Have each student come to the KEVA box and count out 30 planks into a container. Several students can do this at a time as the entire class counts aloud with them, or small groups could come to the box and count quietly together. Dividing your planks into several large piles will speed up this process.
- 2.** Allow the children to each build a structure with their planks. You could have an open theme for building or require a certain type of structure (for example: towers, houses, animals or vehicles).
- 3.** Allow time to observe each structure.
- 4.** Tell the class that it is time to collapse their structures, and that we will do this all together. Remind them that this needs to be done gently.
- 5.** As a group, count down to destruction time. 10, 9, 8, 7, 6, 5, 4, 3, 2, 1!
- 6.** Have everyone count aloud as they return their pieces to their boxes. If time permits, repeat with another building project.

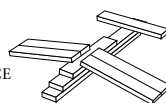
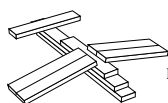



Number Recognition

OBJECTIVE: Students will identify the number of objects in a set and the correct corresponding numeral.

MATERIALS:

- 55 KEVA planks per student or small group
- 10 sheets of paper with numbers 1–10 written in each corner

PROCEDURE:

1. Have each student count out and place the appropriate number of planks on each paper.
2. Students may form patterns or towers with the planks in each of the appropriate boxes.

BUILDING EXTENSION: Make a mat or squares as above, but leave the numbers off. Have the students build towers on each of the squares with varying amounts of KEVA planks. Another student can then identify the correct number of planks. Have the student write the amount on a small piece of paper and place it on the corresponding squares. The builder can then check the answers.

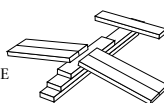
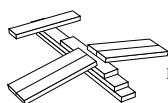



Reasonable Guess of Magnitude

OBJECTIVE: Students will build structures involving varying quantities in the ones, tens and hundreds places.

MATERIALS:

- 1,000 KEVA planks per student or small group
- Index cards

PROCEDURE:

- 1.** On index cards write the three numbers to be used. One card should have 1, 10 and 100; the next card should read 2, 20 and 200; and so on.
- 2.** Have the students choose one card and count out the appropriate number of planks for each of their three structures. Students can build anything they would like with the correct number of planks in each structure.
- 3.** Students can now label their structures by folding an index card in half and writing the correct number on the card. The label should be placed in front of each structure so that throughout the day classmates can view the structures along with the labels.
- 4.** Another option would be for the three structures to remain unlabeled, and classmates could guess which is made of ones, which is made of tens and which is made of hundreds of KEVA planks.
- 5.** The next group to build can put away the planks for the first group before they begin step number 2.

BULLETIN BOARD IDEA: Take pictures of the structures and post them on a bulletin board. Divide your bulletin board into three sections labeled ones, tens and hundreds.

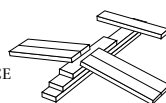
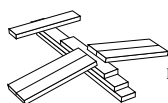



Adding with KEVA®

OBJECTIVE: Students will use KEVA planks as a manipulative to illustrate addition problems.

MATERIALS:

- 20 KEVA planks per child
- Addition sheet for each child (*See Appendix A*)

PROCEDURE:

- 1.** Demonstrate the concept of pulling out one handful of planks, counting your planks and writing the numeric value on your paper in the first column. One handful will ensure a value of less than 10. Make a small stack with your handful of planks.
- 2.** Make an addition symbol (+) out of planks to the right of your stack.
- 3.** Grab another handful of planks. Count out its numeric value and write this on your paper. Place this handful of planks on the other side of your + sign.
- 4.** Make an equal sign (=) out of planks and place it to the right of this second stack.
- 5.** Count all your planks together. Write this number on your paper. Count out that many planks and place this stack on the other side of your equal sign.
- 6.** Repeat steps 1–5 above with varying numbers of planks added together.

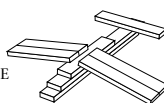
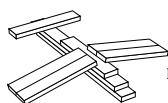



Subtracting with KEVA® (or "The KEVA Bandit")

OBJECTIVE: Students will use KEVA planks as a manipulative to illustrate subtraction problems.

MATERIALS:

- Up to 20 KEVA planks per child
- Subtraction sheet for each child (*See Appendix B*)

PROCEDURE:

- 1.** Have students grab a large handful of planks from the bin. If you wish to use larger numbers, have them grab two handfuls. Your goal is to distribute random amounts between 10 and 20 planks per child.
- 2.** Have each student fill in the numeric value of their planks on their paper in the first column.
- 3.** Now tell the class that you are the KEVA Bandit (or the KEVA Taxman, or the KEVA Gobbling Monster). You will be coming around and collecting a certain number of planks. Show the class how many planks you will be collecting. Have them write this amount on their paper after the minus sign and place that amount of planks on their desk so you can grab it. You may assign KEVA Bandit helpers if you wish.
- 4.** Now tell the class to count the amount they have left. Have them write the numeral in the answer place on their worksheet.
- 5.** Repeat steps 1–4 above with a new KEVA collection amount.

BUILDING EXTENSION: The KEVA Bandit and helpers can build a tower with the planks they steal.

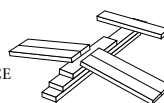
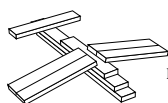



Comparing with KEVA®

OBJECTIVE: Students will use one-to-one correspondence to determine “more,” “fewer” and “same.”

MATERIALS: • 15+ KEVA planks per child

PROCEDURE:

1. Before class, distribute a handful of planks to each student’s container. Be sure that the number of planks in each container varies. The amount you place in the containers depends on how high you want your class to count.
2. Pass out containers, and have each student count out their planks.
3. Explain to the class that today you will be comparing KEVA plank numbers to determine who has more, fewer or an equal amount. Give the class examples of more, fewer and equal amounts. Be sure the class understands that this is not a contest and having more does not mean that you win.
4. Have each student find a partner and stack his or her planks side by side, being sure to keep each child’s planks separate. Ask the students with fewer planks to stand, then those with more, then those with equal amounts.
5. Each child should return his or her planks to the container and repeat the exercise with a new partner. Repeat as often as time allows.

MATH EXTENSION: Introduce greater than, less than and equal signs. Have each child make the three signs on blank cards. The sign, along with the words “less than” and “greater than,” will help students not to confuse the two. As students stand, they can hold up the appropriate sign.

BUILDING EXTENSION:

1. Have each student keep his or her planks in his container. Divide the class into two or three small groups.
2. Demonstrate to the class how to build a simple square tower using the side construction. Begin with two parallel planks. The next rows should be two more planks perpendicular to the first row.
3. Call students one at a time to add their planks to each of the towers. Towers can be built simultaneously.
4. Compare the towers by measuring with a metric stick, yardstick, or a KEVA stick (see Measuring Perimeter with KEVA, page 1.10). You may also compare the towers by holding a straight edge from one tower to the other. Discuss which tower has more, fewer or equal amounts.

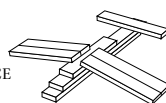
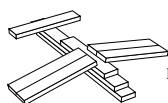



Estimating with KEVA®

OBJECTIVE: Students will make uninformed and informed estimations.

MATERIALS:

- 100 KEVA planks per student or small group
- Index cards
- Envelopes
- Shoe boxes or paper bags
- One data sheet per student (*See Appendix C*)

PROCEDURE:

A. Uninformed Estimation:

1. Divide the class into groups of two or three students. Have each group fill a shoe box with 50 to 100 KEVA planks.
2. Do not tell the class that you will be estimating or that the number of planks is of any significance. Have each group build a tower.
3. Label each of the towers A, B, C, etc. An index card folded in half makes a good label to place in front of each tower.
4. Have each student estimate the number of planks in each tower and record their answers in the "Estimate" column of the data sheet.
5. Have each group go back and count the planks in their own tower. This number should be recorded on the back of each label. Have the class gather this data from each tower and record it in the "Actual" column of their data sheet.
6. Calculate the difference between the estimates and the actual amount. Subtract the smaller number from the larger. You may also want to graph the class results.
7. The class can now quietly collapse their towers and return the planks to the bin.

(continued on next page)

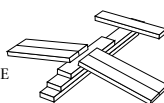
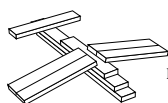



B. Informed Estimation:

1. On the next day or later the same day, have the groups scoop out a new pile of KEVA planks. (You can do this ahead of time and insure more diversity in the amount of planks in each pile.) They should count their planks, being careful to keep this information to themselves. The amount of planks should be written on an index card and placed inside an envelope with the group letter on the outside.
2. Have each group build a tower with their planks. They should place their envelope containing their amount of planks in front of their tower.
3. Tell the class that they now have a frame of reference to begin to make estimations. They know the amount of planks in their own towers. They should use this knowledge to help them make good estimations. This time, as they make estimations, they will be able to open the envelopes and see the actual amount of planks. In this way they will be gaining more and more information and, hopefully, becoming better at estimating the amount of planks in each successive tower.
4. Have the class take their data sheets and visit each tower. Students should record their estimates of the number of planks in the first tower they visit, then open the envelope and record the actual amount. Have students do this for each tower they visit, until they have estimated the planks in each tower. Students can remain in their groups as they do this, but each student should be able to make their estimations individually.
5. Be sure that you do not give the students enough time to count the planks before they are required to move on.
6. Calculate the difference between the estimates and the actual number of planks in each tower. Subtract the smaller number from the larger. You may want to graph the results.

MATH EXTENSION: Collect the data from the class and have each group determine the average differences for the class. Graph these results to see if improvement was made during the estimating process.

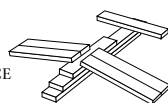
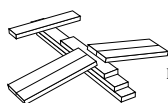



Graphing with KEVA®

OBJECTIVE: Using KEVA planks as counting pieces, students will collect data and construct simple graphs.

MATERIALS:

- Up to 15 KEVA planks per child
- Data sheet for each child (*See Appendix D*)
- Bar graph for each child (*See Appendix E*)
- Graph paper for each child

PROCEDURE:

- 1.** Have each student grab handfuls (using both hands) of planks from the bin (anything between 1–15 per child—you want random amounts distributed to each child).
- 2.** Provide each student with a data sheet. Have each child count out the number of planks in his handful and write the number on his data sheet.
- 3.** Have each child ask five other children to write their name and number of planks on his sheet.
- 4.** Next, have students transfer their data to a bar graph.
- 5.** Make a classroom chart with each child's name and number of planks. Discuss the highest amount, the lowest amount and the amount seen most often.

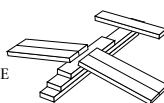
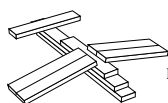



Measuring Perimeter with KEVA®

OBJECTIVE: Students will determine perimeters with a non-standard unit of measurement.

MATERIALS:

- 25 KEVA planks per child
- KEVA yardsticks (*See Appendix F*)
(Several yardsticks per classroom can be shared among students)

PROCEDURE:

1. Discuss the concept of perimeter being the distance around an object.
2. "Today we will be measuring with a unit of measurement that is uniform but not the standard, such as an inch or centimeter would be. We will be using a KEVA length as our unit."
3. Show the class the KEVA yardstick. Show how you could tell how tall a table is with the KEVA yardstick.
4. Have the students construct a triangle using three KEVA planks. What is the perimeter measured with the KEVA yardstick? [3]
5. Have the students construct a square with a perimeter of 4; with a perimeter of 8. Have the students construct a rectangle with a perimeter of 12; a perimeter of 24. Ask if all the rectangles look the same. Is there more than one way to make a rectangle with a perimeter of 20? [Yes.]
6. Write the formula for the perimeter of a rectangle on the board:
 $P = S + S + S + S$ or $P = (2 \times S1) + (2 \times S2)$ or $P = 2 \times (S1 + S2)$
7. Have the students construct rectangles for their neighbors to determine the perimeters.
8. Have students in small groups construct as many different rectangles as they can with perimeters = 16; perimeters = 20; perimeters = 24. (Remind them that a square is a type of rectangle.)

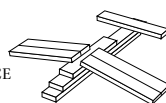
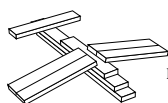



Area (or KEVA²)

OBJECTIVE: Students will calculate the areas of rectangles with KEVA planks.

MATERIALS:

- 25 KEVA planks per child
- One KEVA² template per child (*See Appendix G*)

PROCEDURE:

1. Discuss the concept of area being the space inside a two-dimensional figure.
2. "Today we will be measuring with a unit of measurement that is uniform but not the standard, such as a cubic inch or square centimeter. We will be using a KEVA square as our unit for measuring area."
3. Show the class a KEVA square. Show how you could measure the area of a table with the KEVA².
4. Have the students construct a square using planks that will have an area of 1 KEVA². Constructed on the flat or side edges, the KEVA² will be the space enclosed inside the planks. Always measure the area on the inside of the KEVA figure.
5. Have the students construct a rectangle with an area of 4 KEVA². How many planks were used? [*8 or 10*] Did everyone's look the same? [*No*] Explain that rectangles can have different perimeters but equal areas or equal perimeters and different areas.
6. Write the formula for area on the board:
 $S \times S = A$
7. As a class, construct rectangles with areas of 2 KEVA², 3 KEVA² and 4 KEVA².
8. Have the students form small groups to construct as many rectangles as they can with areas of 6 KEVA², 8 KEVA², 12 KEVA², 24 KEVA².

MATH EXTENSION: Students could also calculate the perimeter of each rectangle and try to see how many different perimeters they can form for each area.

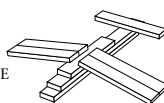
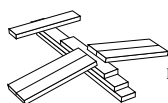



Volume (or KEVA³)

OBJECTIVE: Students will calculate the volumes of objects constructed with KEVA planks.

MATERIALS:

- 50 KEVA planks per child
- One KEVA³ template per student or small group (*See Appendix H*)

PROCEDURE:

1. Discuss the concept of volume being the amount of space inside an object (e.g., how much sand would fill it up?)
2. "Today we will be measuring with a unit of measurement that is uniform but not the standard, such as a pint or liter. We will be using a KEVA length as our unit. A cube that is 1 KEVA length on each side would be 1 cubic KEVA."
3. Have the students construct a cube out of KEVA planks having a volume of 1 KEVA³. Note that 5 KEVA stacked on edge = 1 KEVA length and that 3 KEVA thicknesses = 1 KEVA width. Consequently, the cube can be constructed in a number of ways.
4. Next, have the students construct a KEVA figure having a volume of 2 KEVA³. Note that there are many ways to accomplish this. Some structures can be very tall; some can be low and long.
5. Write the formula for the volume of a rectangular box on the board:
 $V = \text{Length} \times \text{Width} \times \text{Height}$
6. Have the students construct rectangular boxes for their neighbors to calculate the volume.

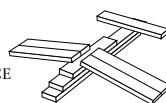
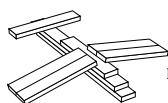



KEVA[®] as a Non-Standard Unit of Measurement

OBJECTIVE: Students will use KEVA planks as a non-standard unit of measurement to measure various items.

MATERIALS: • 10–20 KEVA planks per student

PROCEDURE:

1. Talk with students about why they would need to measure length. [*Buying material, putting up a fence, measuring a rope swing, noting your growth through the years.*]
2. What if we had no instruments with which to measure length? How could you tell how tall you were? [*Taller than Susie, shorter than Joe, use your hands to show, find a stick that is your same height, mark your height on the wall.*] What if you wanted to tell someone who lived far away how tall you were? What could you do?
3. We must be able to say “I am as tall as *something*.” We must be able to fill in that blank with something so that the person would know what we meant. Could I say I am as tall as four pumpkins stacked on top of each other? [*No, because not all pumpkins are the same size—no uniformity.*]
4. We need to find something we can use to stack or lay end to end that will always be the same size. [*Children may suggest books, pencils, coins, etc.*]
5. We will need a large quantity of these if we are going to measure the entire class. [*Children can be led to suggest KEVA planks.*]
6. Use KEVA planks to measure a child lying on the floor, being sure to lay the planks exactly end to end. Have the students measure one another and several things in the classroom and record their measurements. [*As a class, decide how “less than one” plank will be counted.*] This can be done over several days. Each time refer to the objects as “so many KEVA wide” or “so many KEVA high.” Have students check one another’s measurements to see if they get the same results with their planks. Students can also begin to estimate how many KEVA long something is, before they take a measurement.
7. After the class has had several chances to measure with their planks, talk to the class about the need for a standard unit of measurement. What are the difficulties of using KEVA? [*Not everyone has KEVA, and many lengths cannot be measured exactly by KEVA lengths.*]
8. Introduce the English and metric rulers.

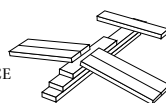
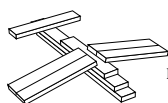



Measuring with KEVA® for Older Students

OBJECTIVE: Students will use the length-to-width ratios of KEVA planks to determine the heights of their towers.

MATERIALS: • 50 to 100 KEVA planks per student or small group

NOTE: KEVA planks are constructed so that 3 KEVA thicknesses equal the width of 1 KEVA, and 5 KEVA widths equal the length of 1 KEVA.

PROCEDURE:

1. Have students attempt to determine the above-mentioned relationships between KEVA planks for themselves.
2. Have the class build towers of varying heights.
3. Using what they have discovered about the ratio relationship of the KEVA planks, the students should now be able to determine the exact height of their towers expressed in KEVA units of height. You may want to determine as a class whether you will record your answers in KEVA heights, thicknesses or widths; or, you may want to allow the students to choose any of these three options.
4. After the height of the towers has been calculated in terms of KEVA, the class can convert their measurements to English or metric units by measuring the dimensions of 1 KEVA plank and multiplying.

MATH EXTENSION: Make this an estimation activity by having students estimate the height of their classmates' towers.

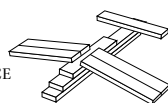
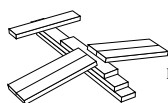



Geometric Shapes with KEVA®

OBJECTIVES: Students will use KEVA planks to construct regular triangles, squares, pentagons, hexagons and octagons.

MATERIALS: • 10 KEVA planks per child Geometric Shapes handout (*See Appendix I*)

PROCEDURE:

1. Discuss the concept of a KEVA plank being a uniform unit.
2. Discuss the concept of a closed figure.
3. As a class, have each student construct closed figures using KEVA planks. Build on the flat sides or the edges; the figure will be the space enclosed inside the KEVA planks. As you call out the name of each closed figure and the number of sides, draw a picture on the board and write the name beside it to reinforce the concept, or provide a handout with figure names and pictures. As you call out each figure, have the students construct that figure using their planks.
4. Have the students write the name of each figure on a slip of paper that has a " ? " written on the back.
5. Have each student select a closed figure to build using planks and place its name on their desks, " ? " side up. Next, have each student go to another student's desk and make a guess about the name of the figure. Turn the slip over to see if they are correct. Repeat. Allow students to use the chart on the board or their answer sheets to check themselves.

BUILDING EXTENSION: For a fun closing activity, have each student build a tower with its base being one of the closed figures.

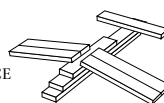
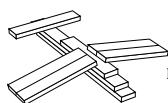



KEVA® Polygons

OBJECTIVE: Students will construct 10 different regular polygons and will demonstrate that the size of interior angles of regular polygons increases as the number of sides increases.

MATERIALS: • 100 KEVA planks per student or small group

PROCEDURE:

1. Have students work individually or in small groups. Tell the students that the interior angles of a regular polygon are all equal. Have each student or group construct the following regular polygons out of KEVA planks, laying blocks flat or on their sides.

Figure	Number of sides
Triangle	3
Square	4
Pentagon	5
Hexagon	6
Heptagon	7
Octagon	8
Nonagon	9
Decagon	10
Undecagon	11
Dodecagon	12

2. Students can label each polygon by writing the name and number of sides on a card.
3. Ask the students to notice what happens to the polygon as the number of sides increases. (Students will easily see that the overall size of the polygon increases. This is true in this activity because the KEVA planks are all the same size. This is a good observation but not the one we are after for this lesson.) Students should be able to see that as the number of sides increases, the size of each interior angle also increases. Younger students may express this by noticing that the figures are becoming more and more round.

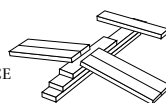
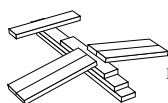



KEVA® Cantilevers

OBJECTIVE: Students will conduct a scientific experiment to determine the weight required to support different lengths of cantilevers.

MATERIALS:

- 100 KEVA planks per group
- One KEVA yardstick per group (*See Appendix F*)
- One Data Sheet per group (*See Appendix J*)
- One Classroom Data Chart per group (*See Appendix K*)

PROCEDURE:

- 1.** Introduce the class to the principle of cantilevers: a cantilever is a projecting beam supported at one end by a counterweight. Demonstrate a cantilever by laying a ruler or yardstick so that it extends over the edge of a table.
- 2.** Before conducting this exercise, discuss with the class the importance of controls in experimental procedures. The edge of the table should be the starting point for each measurement; KEVA planks should be stacked along the end of the yardstick, even with the edge.
- 3.** Divide the class into small groups and ask them to use KEVA to measure how many planks are necessary at one end of a yardstick to support a stack of 2 KEVA planks at the other end of the yardstick when it is hanging over the edge of a table by 6 inches; 12 inches; 18 inches; 24 inches. [*The stack of 2 planks can be taped to the end of the yardstick using a 6" length of tape (control) to cut down on clatter in the classroom.*]
- 4.** Have each group complete a data sheet, then graph their results.
- 5.** You can compile the data from the groups. Explain to the students that this can be done because of the controls used in the experiment. Have the students take an average of the classroom data.
- 6.** Discuss the results with the students. What conclusions can they draw? [*The longer the length of yardstick hanging over the table, the more weight is required to stabilize the cantilever.*]

SCIENCE EXTENSION: You can modify this experiment by fixing the length of yardstick hanging over the edge of the table and varying the number of planks added to each end of the yardstick. What conclusions can the students draw from the results of this modification?

BUILDING EXTENSION: Have students build structures with cantilever designs.

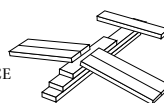
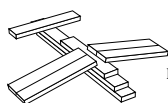



Why Does the Earth Look Flat?

OBJECTIVES: Students will demonstrate that by increasing the number of sides of a regular polygon they will approximate a circle. Students will demonstrate that segments (arcs) of a very large circle can appear straight.

MATERIALS: • 50+ KEVA planks per group

PROCEDURE:

1. Divide the class into small groups. Ask each group to form a closed figure approximating a circular shape with 8 planks (flat construction).
2. Next, form a circular shape with 12 planks. Then with 16 planks. Ask, "What do you notice?" [*The shapes are looking more and more like a circle.*]
3. Form a circle with 40 planks. This will be a circle about 5 feet in diameter. Students will probably reach the right size by trial and error.
4. Ask the students to imagine that they were a ladybug or ant crawling on one of the KEVA Planks. How would a bug describe the shape of the perimeter from its perspective? [*Close to flat.*] What is the actual shape? [*Curved.*]
5. Ask the class to imagine a circle made of 100 planks. How big would it be? [*About 12 feet in diameter.*] Students should be able to note that the curve of the circle would not be as sharp. Imagine a circle built with 1,000 planks. How big would it be? [*About 120 feet in diameter.*]
6. You can reinforce this principle by drawing a 12" diameter circle on the blackboard, then a larger and larger circle, until only a part of the circle will fit on your board. As the circles continue to get larger, the portion of the circle you draw on the board will become straighter and straighter.
7. Now imagine a circle as large as the Earth. [*This would require 341 million KEVA planks.*] From where we are standing, the circle would appear to be flat, but the Earth is round.

KEVA CHALLENGE: Construct a circle with a perimeter of 200 planks on a gym floor. [*Almost 24 feet in diameter.*]

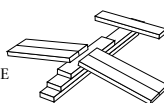
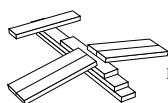

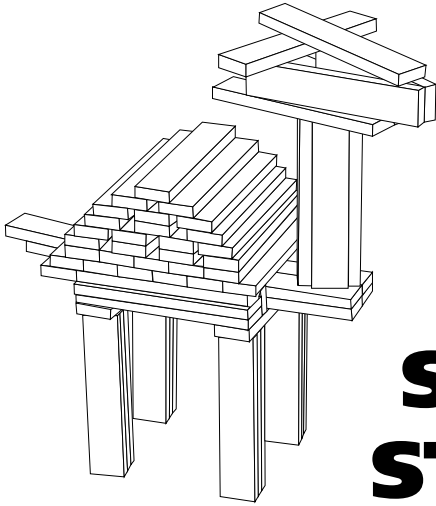

SOCIAL STUDIES



The Battle of Yorktown

OBJECTIVE: Students will demonstrate the British defeat at Yorktown using KEVA planks.

MATERIALS: • 1,000 KEVA planks per group

PROCEDURE:

1. After a study of the British defeat at Yorktown in 1781, tell the class that they will be making a representation of the battle.
2. Divide the class into five groups:
 - The British land forces led by Cornwallis
 - The British Navy
 - The American land forces led by General Washington
 - The French land forces led by Lafayette
 - The French Navy
3. On the floor of your classroom, use masking tape to mark off a rough approximation of the Yorktown Peninsula.
4. Have each group study the map and decide where to place their troops or ships. Each group will decide how to represent their troops. Tents, cannons, individual soldiers, bunkers and ships can all be represented by KEVA planks. Each group can also label their site with a small flag or just the name of the army.
5. After students have re-created the site, have each group report to the class the roles of their particular military forces in the outcome of the war.

LANGUAGE EXTENSION: Have each student write a journal entry from a soldier in their particular regiment from a day of the battle.

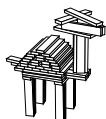



KEVA® Pyramids

OBJECTIVE: Students will re-create Egyptian landmarks using KEVA planks.

MATERIALS: • 100–200 KEVA planks per child

PROCEDURE:

1. Mark off the Nile River on the floor of your classroom using KEVA planks.
2. Assign different groups of students to research different Egyptian structures: the Great Pyramid, lesser pyramids, the Great Sphinx, obelisks, temples and houses.
3. Mark off actual building sites for the pyramids and the Great Sphinx. Allow students to choose spots to place the other structures.
4. Have students build the structures they have researched.

LANGUAGE EXTENSION: After the Egyptian landscape is complete, have each group report to the class on what they built and why it was important to the Egyptians.

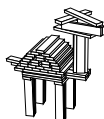



Great Wall of China

OBJECTIVE: Students will re-create the Great Wall of China with KEVA planks.

MATERIALS: • 100 KEVA planks per child

PROCEDURE:

1. Talk to the students about the Chinese empire in 220 B.C. The first Chinese emperor, Chin Shih Huang Ti, faced a problem of invasion from Mongols in the North. Ask the class how would the Mongols probably attack? [*Horseback*] How would they fight? [*Lance, sword, club*] What could the emperor do to protect his people? [*Build a wall*]
2. Read the class *The Great Wall of China* by Leonard Fisher.
3. Ask the class: How many people worked on the wall? [*Over 1,000,000*] How many years did it take to build the wall? [*Over 10 years*] How wide was the wall? [*Wide enough for 10 men to walk side by side*] How far apart were the watchtowers? [*Every 100 yards*] How were the towers used? [*Soldiers kept constant watch for the Mongols and set signal fires when they saw danger.*] How long was the wall when it was finished? [*3,750 miles*]
4. Declare yourself to be the emperor of your class. Tell the class that they must build a Great Wall to protect their class from the Mongol invaders. Tell the class to stop whatever they are doing and begin work at once on the Great Wall.
5. Determine how high and how wide your wall will be. You can divide the class into groups and assign each group a segment along the wall. It is not necessary to have a uniform style as long as you have a uniform height [*two or three KEVA plank-lengths tall*]. Tell the class to think about strength as they build, but to also try to use as few planks as they can so that you can make the longest wall possible. Be sure to include watchtowers.
6. When the wall is completed, tell the students that now they are safe from the Mongol invasion. They have built a strong wall that will protect their entire country.

MATH EXTENSION: The following math applications can be used:

- Estimate the number of planks in your wall.
- How many man-hours did it take to build your wall? [*# of builders x hours time spent building*]
- Measure the length, width and height of your wall.

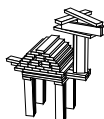



KEVA® Geography

OBJECTIVE: Students will construct a map of the world using KEVA planks.

MATERIALS: • 200–300 KEVA planks per continent

PROCEDURE:

1. You will need a large space, such as a gym floor, to make your map.
2. Assign each group one of the seven continents. Provide students with world maps to use as reference guides.
3. Agree as a class the relative position of each of the continents. These positions can be marked with an “x” of masking tape.
4. As students build, the teacher can make suggestions to enlarge or diminish the size of the continents to keep their sizes relatively proportional.
5. By laying planks flat and overlapping the planks, students will be able to achieve the curves needed to form the continents.
6. Each group should label their continent and surrounding oceans. You can also use KEVA planks laid flat or on edge to show the major rivers on each continent.

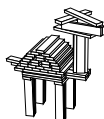



Jamestown Fort

OBJECTIVE: Students will build a replica of the Jamestown Fort.

MATERIALS: • 100–200 KEVA planks per student or small group

PROCEDURE:

1. Brainstorm with the students about what would be needed to house and protect the Jamestown colonists. Pose the question: What buildings would you need to build within the fort? Create a classroom list.
2. Have students compare the classroom list to the actual Jamestown Fort.
3. Divide students into groups and have each group build the Jamestown Fort. The groups will need to decide who will build each of the structures. Discuss with the class the fact that similar decisions had to be made when the real fort was built. How will your group make this decision? How can you keep the decisions fair? (Your groups may use a voting system or a simple first-come first-serve sign-up system.)
4. Tell the class that the groups that work together will be more successful than the groups that argue and do not communicate. Again, links can be made to the early settlers learning to work together.
5. Good planning will also ensure success.
6. Ask the students to think about whether they will have enough planks left over to build the palisade. Can you build each of the structures that you need with the number of planks that you have?
7. Building a fort with KEVA planks will present several challenges due to the properties of planks. Connect this to challenges the colonists faced. Just as the students must figure out how to build a palisade that doesn't topple like dominoes, the colonists had to figure out how to quickly build a structure while still under the threat of enemy attack.

LANGUAGE EXTENSION: Have students write a paragraph about one part of the fort, telling why it is important. They could also write an entry from a journal of a colonist working on the fort.

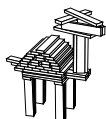



KEVA® Economics

OBJECTIVE: Students will explore the difference between human resources and natural resources.

MATERIALS: • 50–100 KEVA planks per student or small group

PROCEDURE:

1. Be sure each child or small group gets an equal number of planks with which to work.
2. Introduce the terms “natural resources” and “human resources.”
3. Have each child or group build a structure. You could allow any type of structure to be built, or you could specify towers, animals, vehicles or abstracts.
4. After building is completed, walk around the room and compare structures. Some are tall. Some are wide. Some are curvy. Some are straight. What made the difference? [*Human resources.*] What was the same? [*Natural resources.*]

BUILDING EXTENSION: You could extend this lesson over several days by varying the amount of planks each group gets or the number of workers in each group. This would allow for illustrations of scarcity to occur. Larger structures will be built by the groups with more workers and those with more KEVA planks. Discuss with the class the concept of scarcity of human resources and the scarcity of natural resources.

LANGUAGE EXTENSION: Have students write a brief explanation of why workers are important and why natural resources are important.

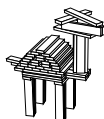



Natural Resources

OBJECTIVE: Students will explore how different people groups use different materials to build their dwellings based on their climate and natural resources.

MATERIALS:

- 100–200 KEVA planks per child or small group
- Habitat Cards (*See Appendix L*)

PROCEDURE:

- 1.** Discuss with the students how different people groups use different natural resources to make their dwellings. Solicit responses from students and compile a list. *For example: Sioux — tepee, Inuit — igloo, Powhatans — longhouses, Zuni — pueblos, American pioneers — log cabins, and southern plantations — brick mansions.*
- 2.** Ask the class, “Why were different materials used?” From their answers emphasize natural resources [*they used what was available*] and habitat [*they made homes to protect them from their environment*].
- 3.** As a research project, have students find one people group with a unique type of dwelling. Have students draw or bring a picture of a dwelling along with a written description of the dwelling, habitat and people group.
- 4. Building Day:** Tell the class that they are going to form small groups that will become a new people group. They will need to come up with a name for themselves and a type of dwelling. They will choose a habitat card, which will tell them their particular habitat.
- 5.** Place the KEVA planks in the center of the room and ask the class what natural resources they have. [*KEVA*]
- 6.** Allow time for the students to build small-scale replicas of their dwellings.
- 7.** Have the groups present their dwelling to the class orally or by writing a travel brochure describing their habitat, people and dwellings.

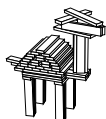

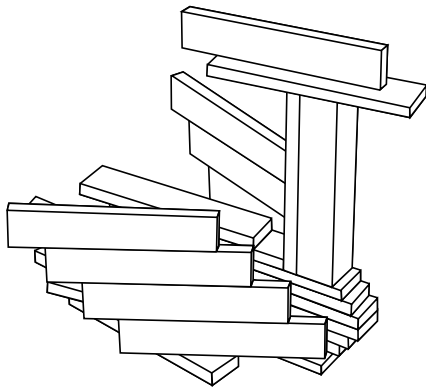

ART

KEVA planks are a sculpture medium that uses only ONE simple building unit yet allows an INFINITE number of construction possibilities. KEVA planks provide a genuine sculpture experience with minimal mess, very quick cleanup and universal appeal for all skill levels and ages.



All-Purpose Lesson Plan for Art

1. Introduce the general art topic. *For example: What is minimalist art?*
2. Issue the challenge or parameters. Most are very simple instructions with an unlimited number of possible responses.
3. Allow sculpting time. (Suggested time varies according to the number of planks available.)
4. Lead students through observations of sculptures. See the discussion questions below.
5. All planks are the same, so all planks go into the same containers. Cleanup usually takes not more than 4 minutes with all students helping—even with 5,000 planks.

CONCLUDING KEVA® ART LESSONS

As you conclude your building sessions with KEVA planks, you may wish to use some of these suggested discussion points to foster critical thinking and to encourage creativity in your students.

- Always take the time to observe and consider the work of the other artists.
- Notice new techniques.
- Notice the effects of patterns.
- Notice difficult balance accomplishments.
- Notice innovative sculptures.
- Challenge students to express an encouraging thought about each sculpture.
- Encourage students to name their sculpture and explain the name.
- Ask students to consider what they might try differently next time.
- Discuss the value to creativity.
- Discuss how sculpture can be used to express emotion.
- Challenge the students to discover what emotions certain sculptures evoke.
- Discuss the value of a sculpture to the sculptor and observers.

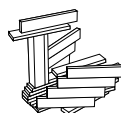
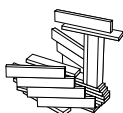



A KEVA® Sculpture Garden

OBJECTIVE: Students will create temporary 3D art with KEVA planks.

MATERIALS: • 100–200 KEVA planks per student

PROCEDURE:

1. Discuss with the class the concept of three-dimensional construction. Students should note that all sides of the piece will be visible. The viewer will be able to walk around the piece to see it from all angles.
2. Also discuss the concept of temporary art (for example, sandcastles, birthday cakes, Christmas trees, light shows, flower arrangements).
3. Have students create their own structures. You may have a completely open-ended assignment, which would include abstract as well as realistic themes. Or, you may want to limit the building to a specific theme such as nature, animals or buildings.
4. After students are finished, conduct a stroll-through tour of the sculpture garden you have created. Have each child tell about his or her piece.

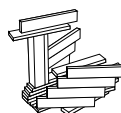
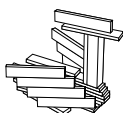



Form and Function

OBJECTIVE: Students will use their imaginations to create artistic and functional cantilever weights.

MATERIALS: • 100–200 KEVA planks per student or small group

PROCEDURE:

1. Review the principles of cantilevers in buildings and bridges (*see page 1.17*).
2. If possible, show the class several bridges and buildings (The Guggenheim and other Frank Lloyd Wright structures are excellent examples of buildings with cantilevers). Discuss how architects use different designs to make their buildings and bridges unique and beautiful. Structures with similar functions can take many different and creative forms.
3. Have each student or group of students construct a structure with at least two cantilever elements. Students should first experiment with basic cantilevers: How far out can their overhang be? Will their cantilevers meet together and form a bridge? How much counter weight will be necessary to support the overhanging weight?
4. You may want to require that they make a rough sketch of their design. The sketches will help the students to make their structures beautiful as well as functional. Counter weight will be required to support the cantilevers. The students must be creative to build this weight in an artistic manner.

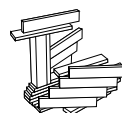
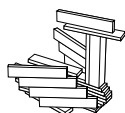



International Architecture

OBJECTIVE: Students will explore and re-create various architectural styles using KEVA planks.

MATERIALS: • 100–200 KEVA planks per student

PROCEDURE:

1. Have students research different types of architecture and bring in pictures from magazines, the Internet or their own sketches. *Examples: Roman Colosseum, Egyptian pyramids, Japanese pagodas, alpine chalets, log cabins, skyscrapers, cathedrals, castles, buildings from the Baroque and Palladium periods.*
2. Discuss how habitat, technology, culture and use of the building affect the overall design of a building. Also discuss how styles change in architecture just as in clothing.
3. Have each student create a structure using KEVA planks that represents a particular style or period.

BUILDING EXTENSION: Advanced students could research the history of architecture and, as a group, create a 3D timeline with representations of major styles.

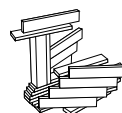
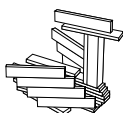



Moving from 2D to 3D

OBJECTIVES: Students will create a two-dimensional drawing and a three-dimensional sculpture of the same subject.

MATERIALS:

- 100–200 KEVA planks per student
- Crayons or markers
- Paper

PROCEDURE:

- 1.** Discuss the concept of two-dimensional and three-dimensional art. Provide students with examples of each.
- 2.** Tell the class that they will be choosing a subject, making a drawing of the subject and then building it out of planks. Discuss the advantages of the two-dimensional representation based on the medium involved (*for example, color can be used; it can be realistic*). Discuss the advantages of using KEVA planks to make a three-dimensional representation (*for example: uniformity, precision, lightweight, fun*).
- 3.** Tell the students to think about how they will create both the drawing and the sculpture before they begin. They may start with either project.
- 4.** Have students display their pictures beside their sculptures and conduct an art show for the entire class.

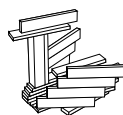
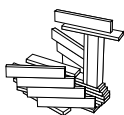



2D Designs

OBJECTIVE: Students will create two-dimensional representations of three-dimensional objects. They will also create two-dimensional designs using pattern repetition.

MATERIALS: • 100–200 KEVA planks per student or group

PROCEDURE:

1. Discuss the concept of two-dimensional art. Provide students with examples.
2. Instruct students to choose an object that they wish to represent in a 2D format.
3. Allow students time to build the object using KEVA planks.
4. Allow time for students to display their work and discuss how they created their two-dimensional art from a three-dimensional object.

BUILDING EXTENSION: Have students create a 2D design using patterns. Instruct them to consider using pattern repetition with lines, circles, spirals, polygons, etc. in their building.

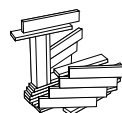
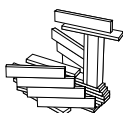



Building 3D Themed Sculptures

OBJECTIVE: Students will create three-dimensional sculptures based on a shape theme.

MATERIALS: • 100–200 KEVA planks per student or group

PROCEDURE:

1. Discuss the concept of building structures with a specific theme in mind.
2. Have students build a base using a triangle, square or other polygon to begin their sculpture. Encourage students to continue using that shape throughout their sculpture.
3. Allow students time to build their sculpture using KEVA planks.
4. Allow time for students to display their work and discuss how they created their sculpture using the chosen theme. Compare and contrast sculptures with similar shape themes.

BUILDING EXTENSION: Have students create sculptures using different types of spirals.

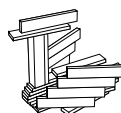
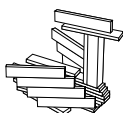



Minimalism

OBJECTIVE: Students will understand the basic principle of using a minimal amount of medium to create a piece of art.

MATERIALS:

- 10 KEVA planks per student
- Photos or examples of minimalism

PROCEDURE:

1. Discuss the concept of minimalism and provide students with examples.
2. Instruct students to choose an object that they wish to represent using KEVA planks.
3. Allow students time to build the object with only the most essential elements (*for example, an airplane with only 3 planks*).
4. Allow time for students to display and discuss their sculpture.

BUILDING EXTENSION: Have students build a sculpture using only 10 planks.

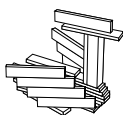



The Same, Yet Different

OBJECTIVE: Students will create KEVA sculptures using the same parameters and then observe the many different results.

MATERIALS: • 100–200 KEVA planks per student or group

PROCEDURE:

1. Establish a constraint by which all students must build. *Example: All planks must remain in groups of two, three, five, etc.; all planks must be stacked flat or vertically; use only 10, 20, 50 planks, only build for 4 minutes, 10 minutes, etc.*
2. Allow students time to build using KEVA planks.
3. Allow time for display and discussion of the students' art.

BUILDING EXTENSION: Have students create a non-uniform structure—one that does not follow a pattern, is non-linear and freeform (island, stack of hay, etc.).

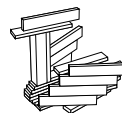
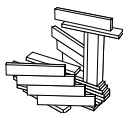



KEVA® Art Games

OBJECTIVE: Students will use KEVA planks to create a large number of different art pieces while fostering communication and teamwork.

MATERIALS: • 100—200 KEVA planks per student or group

PROCEDURES:

Sculptionary

One student builds a representation of an object while others guess what is being built.

Sculptura

One person calls out a stacking orientation while the others stack accordingly
(for example: flat, on edge, upright angled).

KEVAtalk

One person describes precise positioning and all others try to build the identical sculpture without seeing the master.

Impossible Structures

One team builds a structure and removes some of the planks to create a sculpture that could not be built from the ground up. The other team then attempts to re-create the structure and identify the “mystery” behind the sculpture.

fig. 7
Create a base.



fig. 8
Stack the planks to construct a cantilever.



fig. 9
Remove the middle support beam.

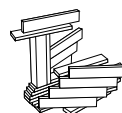
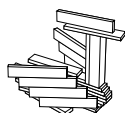

LANGUAGE ARTS

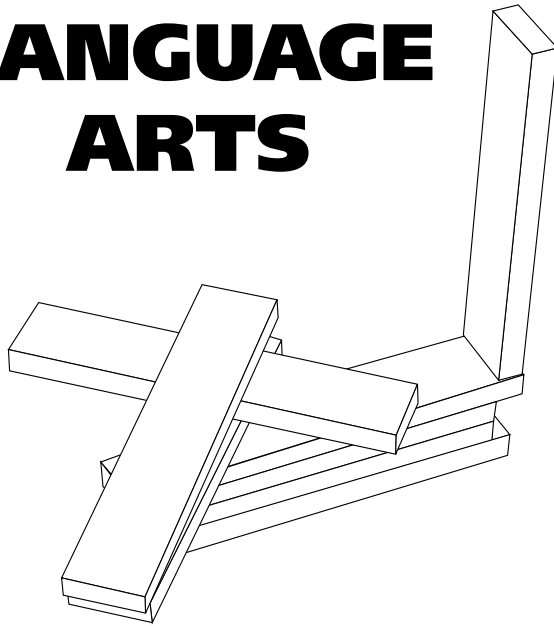



KEVA® ABCs

OBJECTIVE: Students will reinforce their letter recognition by building the alphabet with KEVA planks.

MATERIALS: • 10 KEVA planks per child, per letter

PROCEDURE:

1. This activity can be done as a large group or individually in a learning center.
2. Have the students construct each letter with KEVA planks. Most will probably be done on the flat edge.

BUILDING EXTENSION: Have each student choose a letter and then build an object that begins with that letter. Possibilities: A, airplane; B, boat; C, cat or camel; D, dinosaur; E, elephant; F, fire engine; etc. ...

LANGUAGE EXTENSION: Take pictures of each creation and make a KEVA alphabet book.



Following Directions with KEVA®

OBJECTIVE: Students will follow directions as they build a variety of towers.

MATERIALS: • 20 to 30 KEVA planks per child

PROCEDURE:

- 1.** This lesson is best done in short 10-minute segments over several days. Older children can do this lesson with the terms parallel and perpendicular, while younger children will need a visual cue and the words “in the same way” and “in the opposite way.” Have each student count out their planks and take them to their work area.
- 2.** Demonstrate how to build with KEVA planks on the flat side (*See Basic Instructions for Building*).
 - a.** Tell the class to lay 2 planks flat, parallel to one another (or going in the same direction).
 - b.** Next, have them lay 2 more planks flat on the top of the first 2, but these should be perpendicular to the first row (or going in the opposite way).
 - c.** For the third row, students should lay 2 planks flat so that they are parallel to the first row (or going in the same direction).
 - d.** Continue in this same pattern until all of the planks are used. (Or you may choose an amount to stop with, such as 20 planks.)
 - e.** Ask students to gently collapse their structure and return planks to the storage container.
- 3.** Demonstrate to the class how to build with KEVA planks on edge (*see Basic Instructions for Building*).
 - a.** Tell the class to lay 2 planks on edge so that they are parallel to one another (or going in the same direction).
 - b.** Next have them lay 2 more planks on edge, on top of the first 2. These should be perpendicular to the first row (or going in the opposite way).
 - c.** For the third row, students should lay 2 planks on edge so that they are parallel to the first row (or going in the same direction).
 - d.** Continue in the same pattern until all of the planks are used.
 - e.** Ask students to gently collapse their structure and return planks to the storage container.





- 4.** This time start with 2 planks flat, parallel to one another.
 - a.** For row #2, place 2 planks on edge that are perpendicular to the first row.
 - b.** Guide the class through several layers, alternating rows laid flat with rows on edge. Then allow them to continue on their own.
- 5.** For this tower, begin with 2 planks flat, parallel to each other.
 - a.** Row #2: 2 planks laid flat, perpendicular to row #1
 - b.** Row #3: 2 planks on edge, perpendicular to row #2
 - c.** Row #4: 2 planks on edge, perpendicular to row #3
 - d.** Guide the class through several layers of two flat rows then two edge rows. Then allow them to continue on their own.
- 6.** If students are able to build on end, you may create more complicated combinations of directions. You may also use a triangle, hexagon or octagon as a base for older students, but more planks will be needed for each student.



Build a KEVA® World

OBJECTIVE: Students will work together as a group to create their own world.

MATERIALS: • 100–200 KEVA planks per child

PROCEDURE:

1. Tell the class that they will be creating their own world. (This lesson can be adapted to fit a unit about a country, city, farm, village, island, etc.)
2. Ask the class to suggest things they will need to fill their world. Be sure that items are listed for the following categories: Transportation, Dwellings, Businesses, Artwork, Natural Resources, Public Services.
3. When you are ready to begin building, have the students clear a large space on the floor. Have each child choose 5 KEVA planks and form one zigzag line through the center of the building space.
4. Tell the students that the space on one side of the zigzag line will be land, and the other side will be water. Rivers can be added to extend the water into the land and islands can be built in the sea. Assign students to build on either side. Students can move to the opposite area after they have built one thing on the side they begin with.
5. Students can build whatever they desire, or you can have them choose from a list of items that the class has brainstormed.
6. Students can build independently or in small groups. Allow the students to build for 45 to 60 minutes.
7. Call time, and have students step out and look at the world they have created.
8. Emphasize that by working together they have created a world of their own.

LANGUAGE EXTENSION: Have students write a paragraph about what they built and why it was important to the world. Have each student tell the class what they built and why it is important to the world.



KEVA® Settings, Characters and Plots

OBJECTIVE: Students will use KEVA planks as a manipulative to explore setting, character and conflict.

MATERIALS:

- 100 KEVA planks per child
- Character Description sheet (*See Appendix M*)
- KEVA People sheet (*See Appendix N*)

SETTING

PROCEDURE:

- 1.** Tell the class that over the next few days they will be using KEVA planks to create a setting for a story that they will be writing as a class. Tell the class that the setting is the “where” and “when” of the story.
- 2.** Decide as a class on the type of setting you will create using brainstorming techniques. Think of a name for the place you will create. Consideration might include exotic, familiar, historical, futuristic, big city, small town, farm or castle.
- 3.** Once you have determined the type of setting you will build, as a class make a list of the structures you will need to build. Allow the children to choose the structure they will build from the list and mark it off when they have completed the structure. The setting could be built in one hour-long building session or in several shorter sessions over several days.

WRITING EXTENSION: You may wish to have the students write a paragraph describing their setting. They could be advertising their setting in a travel brochure for an exotic location, writing a history text for a historical place or writing a newspaper article for a modern American setting.

(continued on next page)



CHARACTER

PROCEDURE:

- 1.** Tell the class that they need to create some characters for their story. Again, brainstorm with the class the types of characters they will need. Be sure to include men, women, children and animals. Several professions should also be represented.
- 2.** Provide the children with construction paper and crayons or markers. Have them create people to inhabit the KEVA world they have created. *(See Appendix N.)* The children could freely create their characters or, to insure variety, work off of a brainstorming list.
- 3.** Once the characters are created, have the students add them to their KEVA world.

WRITING EXTENSION: To reinforce the concept, have the students write a description of their character. Have them fill out the character description. *(See Appendix M.)* Older students could transfer this information to a descriptive paragraph.

PLOT

PROCEDURE:

- 1.** Tell the class that a good story must have a plot. Explain that a plot is something that happens to a character in a story.
- 2.** Discuss with the class examples of what could happen within your setting. Make a list, which might include the following: Someone could be rescued from a fire, a thief could rob a store, someone could be lost, an earthquake could occur, etc.

WRITING EXTENSION: Students can now write stories about their characters in the setting they have created. After the stories are written, students can read their stories to the class and place the characters in the appropriate places.



KEVA® News

OBJECTIVE: Students will create a town with KEVA planks and write newspaper articles about events that occur in their town.

MATERIALS:

- 200 KEVA planks per student
- KEVA People handout (*See Appendix N*)

PROCEDURE:

1. Tell the class that they will be building a small town in their classroom.
2. Brainstorm with the class a list of buildings that they will need in their town.
3. Have the students build individually or in small groups. For a well-organized town, have students choose a building from the list. They can check each building off as it is built.
4. Once the town is finished, have the class use the “KEVA People” handout to create people for the town. Again, you can brainstorm with the class a list of occupations for the town. Have students check off the occupations as they make each person and add it to their town.
5. Once the town is populated, the class is ready to create a town newspaper. Talk to students about possibilities for articles. *For example: Fireman Rescues Lady from Burning Apartment, Bank Is Robbed in Broad Daylight, Young Boy Finds Rare Coin, Doctors Save Lives with a New Operation, etc.*

LANGUAGE EXTENSION: Have students write the articles and design and print the newspaper for their new town.



Literature Links

Children will enjoy using their imaginations and KEVA planks to bring a book alive in your classroom. You can adapt this activity to fit any of your favorite books, or use some of the suggestions below.

LITERATURE LINKS FOR OLDER CHILDREN

Detectives in Togas by Henry Winterfield

Synopsis: A detective story set in ancient Rome with seven school boys playing the parts of the detectives. This is a fun and suspenseful story that gives readers the feel of life in ancient Rome.

KEVA Connection: Students can build a Roman temple or the Roman Coliseum. The class could build the Roman Forum together with its temples and official buildings. Much of the story takes place criss-crossing the Forum.

Language Extension: As the class reads the book, have students keep a journal of who they think is the culprit and why. Students will be surprised as they follow red herrings throughout the book.

The Door in the Wall by Marguerite de Angeli

Synopsis: Set in England during the Middle Ages, this book follows the struggles and triumphs of a young boy, Robin, who must overcome many hardships. Robin faces paralysis after exposure to the plague, the dangers of travel among outlaws and a siege upon his castle.

KEVA Connection: The class can build Robin's castle with its inner and outer wall. Chessman or upright KEVA planks can be used to represent the attacking army besieging the castle. The class can reenact Robin's heroic part in the rescue of the castle.

Language Extension: Students can write a ballad telling of Robin's heroic deeds, or they may create their own tales of other gallant knights. The bard in the story would have entertained the Lords and Ladies with such tales of bravery.

The Forgotten Door by Alexander Key

Synopsis: This is a sci-fi book with a glimpse into an alien culture, lightyears ahead of Earth's. While reading it, the children must also solve the mystery of the origin of the young boy, Jon. All the while, the story portrays ordinary heroes and villains who must deal with an alien in their world.

KEVA Connection: Students can build Jon's family's spaceship. Have a contest for the best spaceship design.



Language Extension: Have the students write the newspaper article that will appear in the papers after the disappearance of Jon and the Bean family.

James and the Giant Peach by Roald Dahl

Synopsis: A fanciful story of a young boy named James who escapes his dreary life aboard a giant, magical peach. James' companions on his voyage are a delightful troop of giant insects.

KEVA Connection: Have the class build James' Giant Peach. Students can draw pictures of the insects to add to the peach.

Language Extension: Have the students make a photo album with written descriptions for James and his insect friends. Some of the insects in the story have written poems about themselves. Challenge students to write short poems for their albums.

Little House in the Big Woods by Laura Ingalls Wilder

Synopsis: The story of a young girl, Laura, and her sister and parents living in the backwoods of Wisconsin. This heartwarming story of family love captures the way of life during the pioneer days in America.

KEVA Connection: Have students build Laura's log cabin set in the woods.

Language Extension: Students can write a diary account from the point of view of Laura or Pa. Have students choose their favorite events to write about.

My Father's Dragon by Ruth Stiles Gannett

Synopsis: A young boy, Elmer Elevator, runs away from home to rescue a baby dragon. Along the way, Elmer must use his wits to subdue the wild beasts on Wild Island.

KEVA Connection: Have the students build Wild Island. Using KEVA flat building techniques, students can reproduce the map of Wild Island. Students can use the map and drawings of Elmer, the baboons, lions and dragons to re-tell the story.

Language Extension: Have students write further adventures of Elmer and his dragon friends. They can make up other imaginary lands for their adventures.

Redwall by Brian Jacques

Synopsis: This is an epic tale of a reluctant hero, Matthias the mouse, who lives in the Redwall Abbey. The story is set in a medieval world inhabited by animals that are very human in their capacity for both heroism and villainy.

KEVA Connection: Have the students build Redwall Abbey.

Language Extension: Have students write a ballad about the brave deeds of Matthias. Ballads may be traditional and rhyme, or may be written in free verse.



Stuart Little by E.B. White

Synopsis: The story of an extraordinary mouse named Stuart, who was born into a human family. Stuart has wonderful adventures as a mouse living in the giant world of humans. Stuart's confidence and know-how allow him to triumph over every mishap.

KEVA Connection: Have students build Stuart's sailing boat *The Wasp*. Students could also build a maze for Stuart to find his way out of.

Language Extension: This novel ends with a great deal of ambiguity. Have students write additional chapters for the book.

21 Balloons by William Pene du Bois

Synopsis: *21 Balloons* is an imaginative tale that captures the spirit of invention and exploration of the 1900's. An amateur balloonist is blown off-course and lands on a remote island inhabited by billionaires. The islanders have used their wealth to create an inventor's paradise.

KEVA Connection: Have the students build several of the international houses. Have the class research architecture styles from different countries to replicate the island structures.

Language Extension: Students can write a brief report about the country they have chosen. Students can pick a favorite food from their country and share it with the class in an international feast.

A Wrinkle in Time by Madeleine L'Engle

Synopsis: A young girl, Meg, her friend, Calvin, and her brother, Charles Wallace, travel across galaxies and fight evil alien forces to save Meg's father. This science fiction book is a coming-of-age tale where Meg finally realizes that she possesses the strength to combat the evil force that has held her father in bondage.

KEVA Connection: Have students build the ordered world of the city on the Red Planet. Discuss pattern and symmetrical design.

Language Extension: Meg's story is the story of a young girl beginning to take on the responsibility of the adult world. Have students write about what they plan to do as adults. They can write about career goals, education plans, dreams and aspirations, as well as any fears they might have.



LITERATURE LINKS FOR YOUNGER CHILDREN

Bam, Bam, Bam by Eve Merriam

Synopsis: A rhyming book with fanciful illustrations tells how construction workers must destroy buildings in order to put up new ones.

KEVA Connection: Have the students construct buildings of all shapes and sizes. Then have them move a few feet away and use bean bags or foam balls to topple the buildings.

The Banshee Train by Odds Bodkin

Synopsis: A ghostly tale of a mysterious train that warns of a washed out trestle bridge.

KEVA Connection: The students can build the trestle bridge that spans Gore Canyon. As a class, build an elevated track around your classroom.

Builder of the Moon by Tim Wynne-Jones

Synopsis: A young boy flies into space to rebuild the moon with his building blocks.

KEVA Connection: Have students rebuild the moon. Building round shapes with straight lines is a great design challenge. Point out illustrations in the book showing one way it could be done. Note: a full moon is shown in the books but a half moon or a quarter moon could also be done.

Language Extension: Have students write thank-you notes from the moon to David.

City Street by Douglass Florian

Synopsis: A picture book that gives brief glimpses of life in a big city.

KEVA Connection: As a class, build a city. Plan the things you will need: buildings, parks and transportation. Assign groups to build each part.

Language Extension: Label your city. Have students write the name of their buildings on an index card and prop it in front of their creation. Have each student tell the class about what they created and why it is important to the city.

The Dream House by Pirkko Vainio

Synopsis: Lucas builds his dream house on an island near the seashore, only to find he is lonely. In his boredom, he adds room upon room to his house, creating a tower. The wind bends his tower making it a bridge to the shore and friends.

KEVA Connection: Have the students re-create the shoreline and Lucas's house. Build a bridge to connect the shore to the island. Add children. (See *KEVA People* handout, Appendix N.)

Language Extension: Have students write short essays on the topics:

"I feel lonely when..." "I would like to build a bridge to..."



Hosni the Dreamer by Ehud Ben-Ezer

Synopsis: Hosni is a shepherd for a wealthy sheik. Hosni dreams of a faraway city and is ridiculed for his fantasy. By listening to a wise proverb, he is able to realize his dream.

KEVA Connection: Build the city in Hosni's dream with its walls, stairs and minarets.

Language Extension: Have students describe their "dream" place. What does it look like? Why is it special? Why is it different? How will you get there?

A House Is a House for Me by Mary Anne Hoberman

Synopsis: Countless things are depicted as "houses" for the items they contain. Social studies and science topics are dealt with in imaginative, witty poetry.

KEVA Connection: Choose a "house" from the book and build it.

Language Extension: Make a classroom list of more "houses" and their occupants. Have the class write short poems about one or more of the new houses.

Look at the Moon by Mary Gardlick

Synopsis: A beautiful description of the whole Earth as the moonlight sweeps over it.

KEVA Connection: Have the students choose a setting, animal, building or object that the moon sees and build it. Or, divide the class into groups to build a city, woods, ships at sea, a jungle, the Arctic or other regions.

The Maid and the Mouse and the Odd-Shaped House by Paul Zelinsky

Synopsis: A maid and a mouse build an odd little house that, with the help of clever illustrations, turns into a cat.

KEVA Connection: Have students build their own odd-shaped houses. Emphasize unique building features—the odder the better.

Language Extension: Have the children pretend to be a real estate agent who will show you around their odd-shaped house. Have them write up a description of the house for the newspaper.

Mimi and the Dream House by Martin Waddell

Synopsis: Mimi the mouse decides to build a house. Her sisters and brothers design and build her fancy houses, but Mimi rejects them and builds a house suited for her, where everyone can visit.

KEVA Connection: Have students build a dream house for themselves. If time permits, have them make a drawing of their house before they build, as Mimi did.

Language Extension: Have students briefly describe their dream houses to the class telling what is special about their creation.



Mystery Mansion by Michael Garland

Synopsis: Tommy receives a mysterious note from his aunt, which sends him on a trip through her enchanted mansion in search of clues. The illustrations in the book contain clues that help the reader and Tommy solve the riddle.

KEVA Connection: Build Aunt Jean's mansion. Create some of the animals you see. Make a maze.

Language Extension: Have small groups make mazes using KEVA planks. Have them begin a scavenger hunt with the riddle in the center of the maze. One or two other stops in the scavenger hunt will provide plenty of movement in a classroom. Be sure the riddle for the next stop is found at the answer for the first riddle. Riddles can be as simple as "look beside the pencil sharpener." The answer can be as simple as "You found me."

Oh, the Places You'll Go by Dr. Seuss

Synopsis: A challenge to get up and go, with your imagination and determination as your only limits. Zany challenges and wacky encounters are all a reflection of real-life experiences.

KEVA Connection: Build your dream "place." Make it as exotic, zany and creative as you can.

Language Extension: Briefly describe the place you have built. What is it called? What does it look like? What can you do there? Read the descriptions aloud to the class and try to match the description to the creation.

People, People Everywhere by Nancy Van Laan

Synopsis: The hustle and bustle of city life is contrasted with the quiet countryside. Both are filled with people.

KEVA Connection: Divide the class into two groups. Have one group build a city and one group build a small town or farm.

Language Extension: Have each student write or tell about the place that they would rather live and why.

Rotten Island by William Steig

Synopsis: Rotten Island has rotten weather and horrible, cranky creatures that love to hate one another. A flower blooms into this nastiness, sending the creatures into chaos.

KEVA Connection: Make a rotten island in your classroom. Form the perimeters of the island with a single flat row of planks. Add a KEVA planks volcano and creatures. Plant a flower (paper cutout) in the middle, and have a KEVA planks battle by tossing beanbags or foam balls at your creatures.

Language Extension: Think of a name for the new island and write about who will come to live there.



Steel Beams and Iron Men by Mike Cherry

Synopsis: A personal look at the job of constructing skyscrapers and bridges. Lots of new vocabulary as you learn about gofers, pushers and spud wrenches. A first-person account of the courage required to work far above the ground.

KEVA Connection: Build skyscrapers from KEVA planks.

Math Extension: Calculate the ratio of the height of your building to that of an actual skyscraper.

Zoo-Looking by Mem Fox

Synopsis: Flora visits the zoo with her dad and sees many animals doing interesting things. The book is illustrated in collage.

KEVA Connection: Make a classroom zoo with KEVA planks. Invite guests to visit your zoo.

APPENDICES

- A. Adding with KEVA
- B. Subtracting with KEVA
- C. Estimating with KEVA
- D. Graphing with KEVA • Data Sheet
- E. Graphing with KEVA • Bar Graph
- F. KEVA Yardstick
- G. KEVA² Template
- H. KEVA³ Template
- I. Geometric Shapes
- J. KEVA Cantilevers • Data Sheet
- K. KEVA Cantilevers • Classroom Data Chart
- L. Habitat Cards
- M. Character Description
- N. KEVA People



Adding with KEVA®

ADDITION SHEET

Name: _____ Date: _____

1.		+		=	
2.		+		=	
3.		+		=	
4.		+		=	
5.		+		=	
6.		+		=	
7.		+		=	
8.		+		=	
9.		+		=	
10.		+		=	



Subtracting with KEVA®

SUBTRACTION SHEET

Name: _____ Date: _____

1.		-		=	
2.		-		=	
3.		-		=	
4.		-		=	
5.		-		=	
6.		-		=	
7.		-		=	
8.		-		=	
9.		-		=	
10.		-		=	



Estimating with KEVA®

DATA SHEET

Name: _____ Date: _____

	Estimate	Actual	Difference
A			
B			
C			
D			
E			
F			
G			
H			
I			
J			



Graphing with KEVA®

DATA SHEET

Name: _____ Date: _____

Student Names	Number of Planks



Graphing with KEVA®

BAR GRAPH

Name: _____ Date: _____

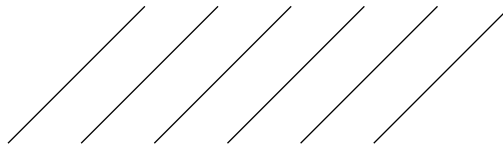
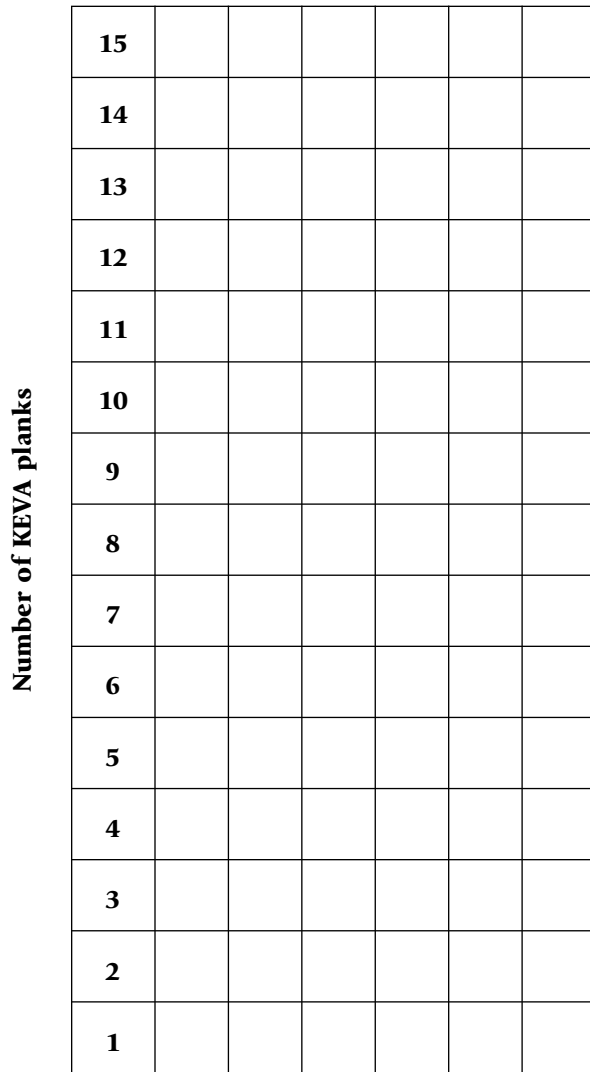

Name of Student



KEVA® Yardstick

Directions for KEVA Length

You can make numerous KEVA measuring strips by photocopying the strip template and having students follow these directions:

1. Cut out each of the three strips.
2. Tape each of the pieces end to end.

Optional: Laminate your strip or cover with clear contact paper.

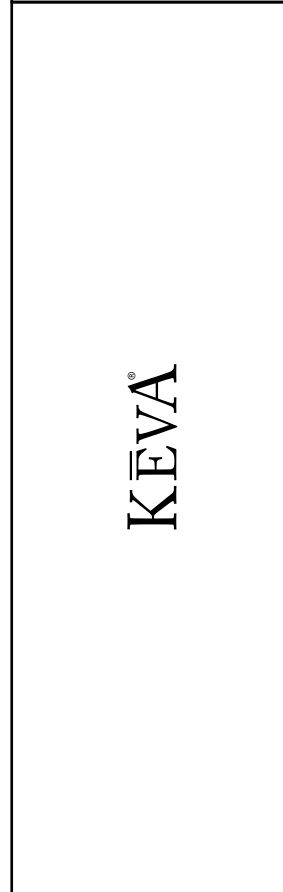
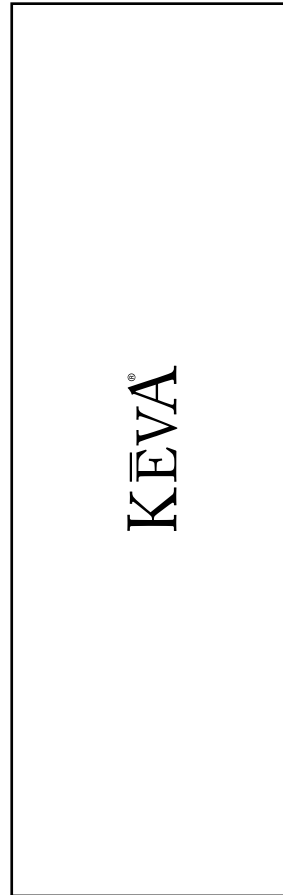
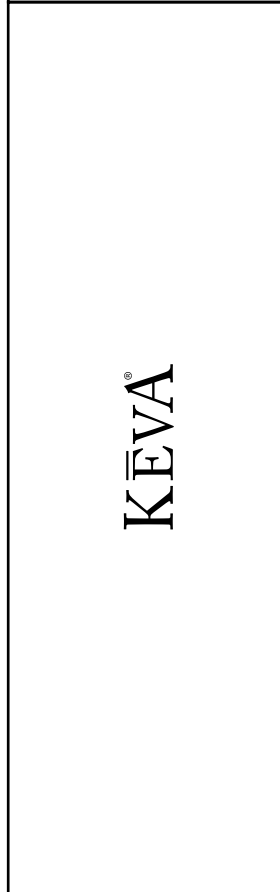
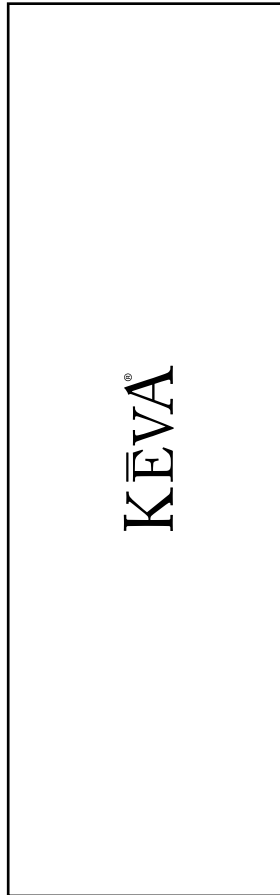
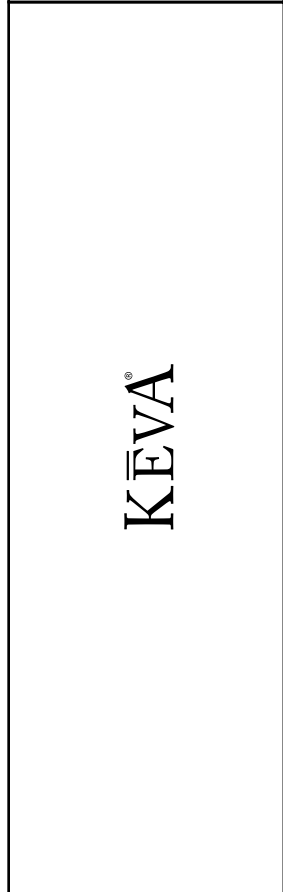
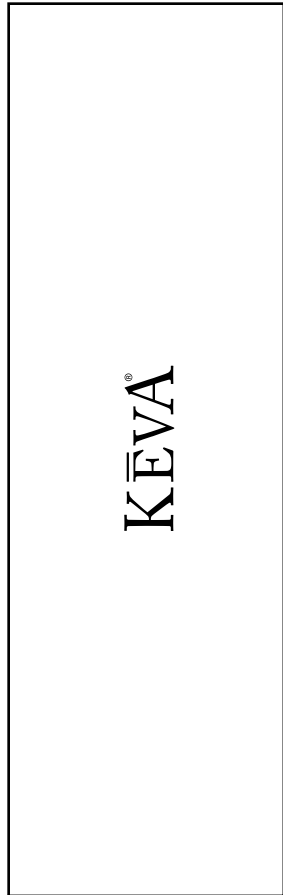



KEVA² Template

KEVA²



KEVA³ Template

DIRECTIONS:

1. Place the KEVA² template on a 15-inch by 15-inch sheet of paper.
2. Trace around the template.
3. Trace around each of the KEVA³ templates as shown.
4. Cut out the cross-shaped figure.
5. Fold along every line.
6. Glue each of the tabs to the inside of the box.

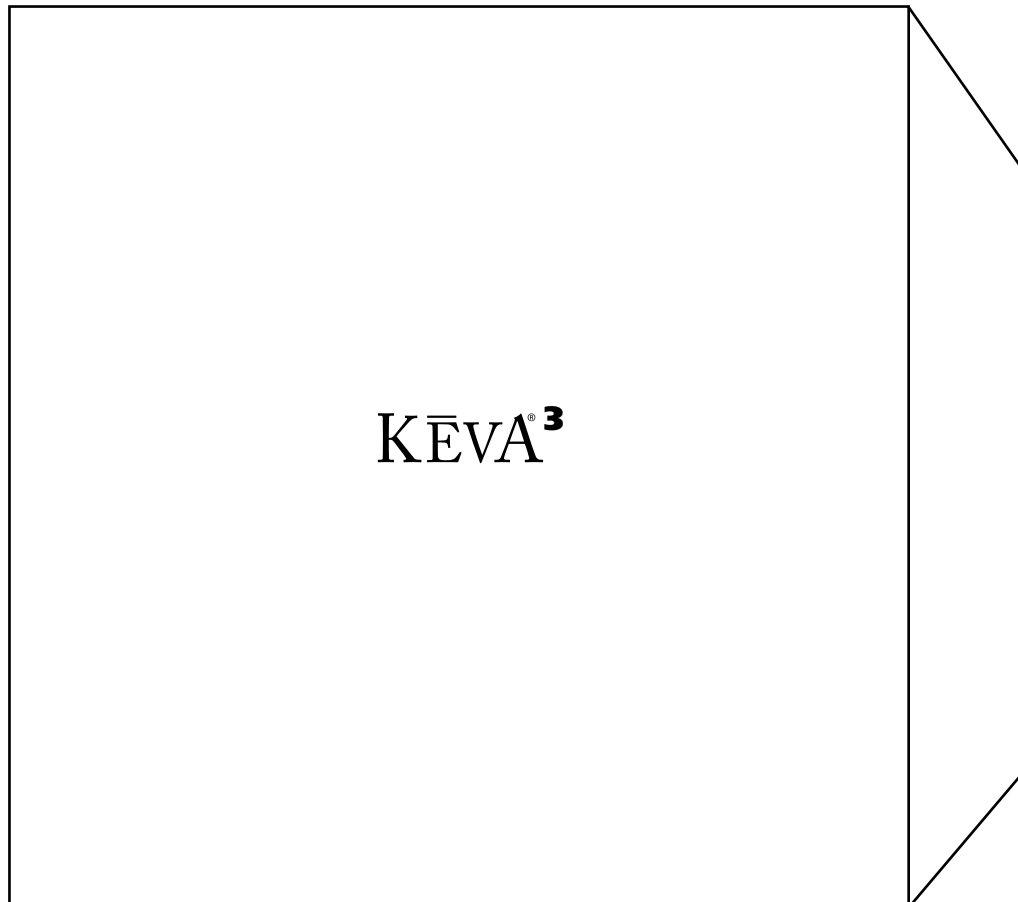
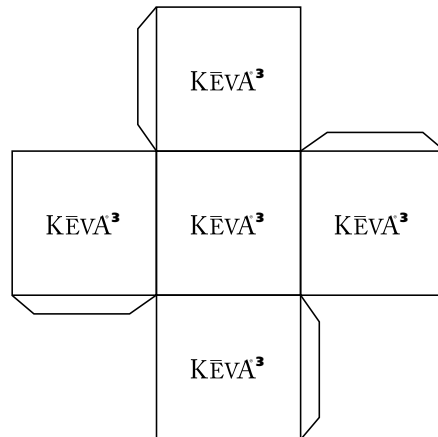



Geometric Shapes

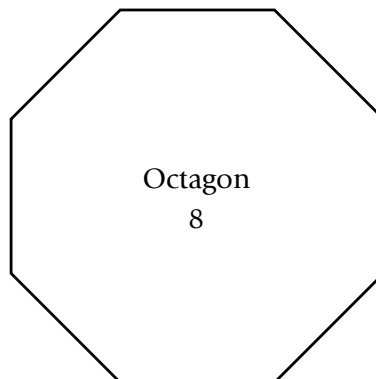
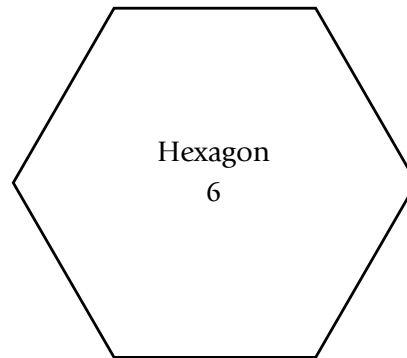
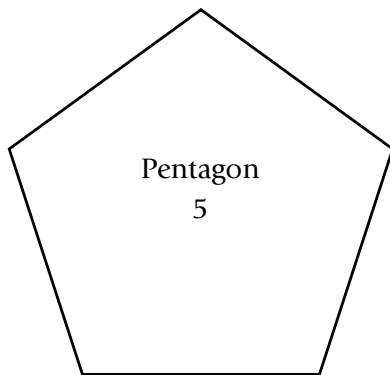
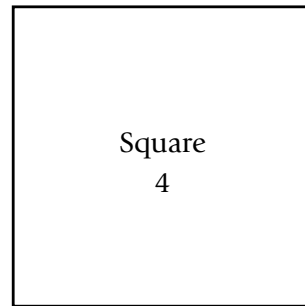
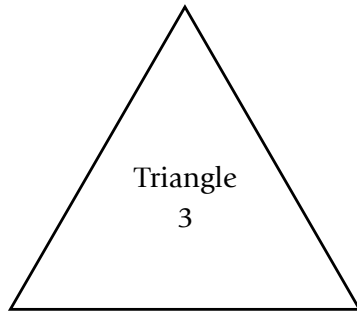



KEVA® Cantilevers

DATA SHEET

Name: _____ Date: _____

Using single measurements:

Length of yardstick extending past the edge of the table	Number of planks required for balance
_____ inches	
_____ inches	
_____ inches	
_____ inches	
_____ inches	

Using replicate measurements:

Length of yardstick extending past the edge of the table	Number of planks required for balance		Average of two trials
	Trial #1	Trial #2	
_____ inches			
_____ inches			
_____ inches			
_____ inches			
_____ inches			



KEVA® Cantilevers

CLASSROOM DATA CHART

Name: _____ Date: _____

Length of yard-stick extending past the edge of the table	Results Group 1	Results Group 2	Results Group 3	Results Group 4	Results Group 5	Results Group 6	Average
inches							
inches							
inches							
inches							
inches							



Habitat Cards

volcanic
island

mountains

flood
plain

desert

tropical
rain forest

Arctic

plains



Character Description

Character Name: _____ Age: _____

Occupation: _____

Interests/Hobbies: _____

Family: _____

Write three to five sentences to introduce and describe your character:



KEVA® People

Use the outlines to create characters for your story. Then cut them out and place them inside the KEVA world the class has created.

